

DXN MARKETING PLAN
DISTRIBUTOR RULES AND REGULATIONS



DXN Marketing India Private Limited
www.dxnindia.in

Dear Distributor,

Welcome to the DXN family !

Congratulations, for making a right choice of taking a quantum leap towards financial independence and time flexibility with DXN. We believe both are within your reach as you have taken the crucial step to join in our business.

DXN practices the concept of "**One World One Market**" where you will have the opportunity to expand your business not only in your country but the world over to enjoy worldwide business with a single distributor card.

At DXN, we uphold the philosophy of providing **Low price, High Quality** products while generating **High Income** by applying cutting edge practices in Multilevel Marketing to ensure top Performance. We believe this business idea has spillover effects that will reach out to those who strive for better health financial freedom and personal achievement.

We believe that if we work together, we can achieve

HEALTH ! WEALTH ! AND SUCCESS

Once again, our Management and staff would like to extend a warm welcome to you for joining our DXN global family.

See you at the Top,

Thank you,

Management
DXN Marketing India Pvt Ltd.

DXN MARKETING PLAN

Definition of Terms

PV	:	Point Value, for qualification and status.
SV	:	Sales Value, for calculation of Bonus and Incentive.
Personal Point Value (PPV) / Personal Sales Value (PSV)	:	Total PV/SV generated from all personal cash bills transacted in a month.
Personal Group Point Value (PGPV) / Personal Group Sales Value (PGSV)	:	Total PV/SV generated in a month by all downline distributors within personal group (ie. excluding breakaway QSAs) and own PPV/PSV.
Diamond Group Point Value (DGPV) / Diamond Group Sales Value (DGSV)	:	Total PV/SV generated in a month by all downline distributors within your diamond group (ie. excluding breakaway QSDs) and own PPV/PSV.
Qualified Star Agent (QSA)	:	Any SA who maintains 3,000PPV in a month. Any Diamond who qualifies for 37% Star Group Bonus.
Qualified Star Diamond (QSD)	:	Any SA and above who meets the Yearly Travel
Travel Seminar Qualifier	:	Seminar Incentive Points (TSIP) Quota set of the year.

Introduction Of Remuneration

1) Retail Profit ----- > 15%

2) Bonus (71%) and Cash Incentive (Rs.135,000)

a) Group Bonus -----	6% - 21%
b) Star Group Bonus -----	25% - 37%
c) Development Bonus -----	15%
d) Group Incentive -----	2%
e) Leadership Bonus -----	15%
f) Travel Seminar Incentive -----	2%
g) One Time HP Cash Incentive -----	Rs.15,000
h) One Time Overseas Trip Cash Incentive -----	Rs.120,000

Status

Status	Condition
Distributor	Age 18 years and a sponsor.
Star Agent (SA)	Achieves accumulated Group Sales of 45,000PV
Star Ruby (SR)	Sponsors 3 First Generation Star Agents (SA)
Star Diamond (SD)	With 6 First Generation Star Agents (SA) & qualifies for 37% Star Group Bonus.
Executive Star Diamond (ESD)	Star Diamond who sponsors 1 Star Diamond
Senior Star Diamond (SSD)	Star Diamond who sponsors 2 Star Diamonds*
Executive Senior Star Diamond (ESSD)	Star Diamond who sponsors 3 Star Diamonds*
Double Diamond (DD)	Star Diamond who sponsors 4 Star Diamonds*
Executive Double Diamond (EDD)	Star Diamond who sponsors 5 Star Diamonds*
Triple Diamond (TD)	Star Diamond who sponsors 6 Star Diamonds*
Executive Triple Diamond (ETD)	Star Diamond who sponsors 7 Star Diamonds*
Gold Diamond (GD)	Star Diamond who sponsors 8 Star Diamonds*
Executive Gold Diamond (EGD)	Star Diamond who sponsors 9 Star Diamonds*
Crown Diamond (CD)	Star Diamond who sponsors 10 Star Diamonds*
Executive Crown Diamond (ECD)	Star Diamond who sponsors 11 Star Diamonds*
Senior Crown Diamond (SCD)	Star Diamond who sponsors 12 Star Diamonds*
Executive Senior Crown Diamond (ESCD)	Star Diamond who sponsors 13 Star Diamonds*
Double Crown Diamond (DCD)	Star Diamond who sponsors 14 Star Diamonds*
Executive Double Crown Diamond (EDCD)	Star Diamond who sponsors 15 Star Diamonds*
Triple Crown Diamond (TCD)	Star Diamond who sponsors 16 Star Diamonds*
Executive Triple Crown Diamond (ETCD)	Star Diamond who sponsors 17 Star Diamonds*
Gold Crown Diamond (GCD)	Star Diamond who sponsors 18 Star Diamonds*
Executive Gold Crown Diamond (EGCD)	Star Diamond who sponsors 19 Star Diamonds*
Crown Ambassador (CA)	Star Diamond who sponsors 20 Star Diamonds*

* As per dynamic compression.

Remuneration in DXN Marketing Plan

1. Retail Profit (> 15%)

Direct profit for distributors is when they sell DXN products to non-DXN members.
Retail profit is the difference between distributor price and maximum retail price.

2. Group Bonus (6% - 21%)

To be entitled for this Group Bonus, you need to maintain 1,000PPV each month.

Accumulated Group PV	Bonus
45,000 and above	21%*
32,500	18%
20,000	15%
10,000	12%
3,000	9%
1,000	6%

* If a Star Agent (21%) maintains 3,000 PPV, he will become a Qualified Star Agent (25%).

3. Star Group Bonus (25% - 37%)

To be entitled for this Star Group Bonus, you must be a SA and maintain 3,000PPV(QSA) each month.

No. of SA (1st Generation)	No. of Qualified SA Lines	DGPV	Bonus
6	-	50,000	37%
	4	25,000 #	
5	-	30,000	35%
	4	20,000	
4	4	-	33%
3	3	-	31%
2	2	-	29%
1	1	-	27%
0	0	-	25%

For SSD and above, if the number of QSD is more than one, then the DGPV can be borrowed from one of the QSD and the number of QSD will be reduced by one.

4. Development Bonus (15%)

To be entitled for this Development Bonus, you must be a SA and maintain 3000PPV (QSA) each month.

Level of Qualified SA	Bonus
1st Level	5%
2nd Level	4%
3rd Level	3%
4th Level	2%
5th Level	1%

5. Group Incentive (2%)

To be entitled for this Group Incentive (GI) you must be a Qualified Star Diamond (QSD)

GI Fund = Overall Company's Sales in SV X 2%

Your GI entitlement

=	GI Fund	X	$\frac{\text{Your GI Point for the month}}{\text{Total GI Point for all Qualified Star Diamonds and above}}$
---	---------	---	--

- Your GI Point calculation:

Level of Qualified SD	GI Point			
Personal			DGSV	X 100%
1st Level QSD (L1)	+	L1	DGSV	X 50%
2nd Level QSD (L2)	+	L2	DGSV	X 40%
3rd Level QSD (L3)	+	L3	DGSV	X 30%
4th Level QSD (L4)	+	L4	DGSV	X 20%
5th Level QSD (L5)	+	L5	DGSV	X 10%

7. Travel Seminar Incentive (2%)

This Travel Seminar Incentive(TSI) shall be used by the qualifier for the travel seminar organised by the Company only. It is not exchangeable for cash and also not transferable. A qualifier may claim up to maximum Travel Seminar Fare against his/her TSI for two(2) if married.

$$\text{Travel Seminar Incentive Fund} = \text{Company's Annual Sales in SV} \times 2\%$$

• To be shared as below:

- i) 50% of the Travel Seminar Incentive Fund (TSIF) to be shared amongst all SA and above who met the YEARLY TSIP QUOTA set for the year.
- ii) 50% of the Travel Seminar Incentive Fund (TSIF) to be shared amongst all SD and above who met the YEARLY TSIP QUOTA set for the year.

a) Travel Seminar Incentive for SA Qualifier (TSI_{SA})

$$\text{TSI}_{\text{SA}} = 50\% \times \text{TSIF} \times \frac{\text{Accumulated TSIP* for a SA Qualifier}}{\text{Total Accumulated TSIP for all SA Qualifiers}}$$

* Travel Seminar Incentive Point (TSIP) will be calculated monthly based on the following formula and to be accumulated for a year:

Level of Qualified SA	Monthly Travel Seminar Incentive Point (TSIP)			
Personal			PGSV	X 100%
1st Level QSA (L1)	+	L1	PGSV	X 50%
2nd Level QSA (L2)	+	L2	PGSV	X 40%
3rd Level QSA (L3)	+	L3	PGSV	X 30%
4th Level QSA (L4)	+	L4	PGSV	X 20%
5th Level QSA (L5)	+	L5	PGSV	X 10%

b) Travel Seminar Incentive for SD Qualifier (TSI_{SD})

$$\text{TSI}_{\text{SD}} = 50\% \times \text{TSIF} \times \frac{\text{Accumulated TSIP* for a SD Qualifier}}{\text{Total Accumulated TSIP for all SD Qualifiers}}$$

* Travel Seminar Incentive Point (TSIP) will be calculated monthly based on the following formula and to be accumulated for a year:

Level of Qualified SD	Monthly Travel Seminar Incentive Point (TSIP)			
Personal			DGSV	X 100%
1st Level QSD (L1)	+	L1	DGSV	X 50%
2nd Level QSD (L2)	+	L2	DGSV	X 40%
3rd Level QSD (L3)	+	L3	DGSV	X 30%
4th Level QSD (L4)	+	L4	DGSV	X 20%
5th Level QSD (L5)	+	L5	DGSV	X 10%

8. Hand Phone Cash Incentive (Rs.15,000) - One Time Only

When you have 3 immediate SA's who achieved 60,000 Accumulated GPV, then you will be entitled to receive this **One Time** Hand Phone Cash Incentive amounting to Rs.15,000.

* Only personally sponsored downlines counted.

9. Overseas Trip Cash Incentive (Rs.120,000) - One Time Only

When you have 5 immediate downlines who have received their Hand Phone Cash Incentive, then you will be entitled to receive this **One Time** Overseas Trip Cash Incentive amounting to Rs.120,000.

* Only personally sponsored downlines counted.

Explanation On The DXN Marketing Plan Reward

1. Retail Profit (>15%)

Direct profit for distributors is when they sell DXN products to non-DXN members. Retail profit is the difference between distributor price and maximum retail price.

Example:

If you sell one unit of DXN Product to a non-DXN distributor, you will earn the retail profit as below:

One unit of DXN Product	
Distributor Price	Rs.250
Maximum Retail Price	Rs.300

Therefore,

Maximum Retail Price – Distributor Price = Retail Profit
Rs.300 – Rs.250 = Rs.50

YOUR retail profit is Rs.50 (20% from distributor price)

"The description of how to achieve Star Diamond in 4 months is for illustration purposes only, and should not be construed in any manner as either representing that a particular individual will be able to achieve such status or that achieving this position is easy. Individual results will vary."

* Assume 1PV = 1SV for all the following Bonuses and Incentives calculations.

2. Group Bonus (6%-21%)

CASE 1

If in the first month you have acquired 1,000PV and sponsored 3 new distributors with 5,000PV each:

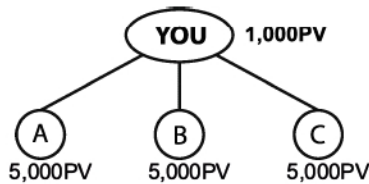

Personal PV/SV (PPV/PSV) = 1,000PV/SV
 Personal Group PV/SV (PGPV/PGSV) = 16,000PV/SV

Your Group Bonus = (16,000SV X 12%) - (5,000SV X 9%)
 - (5,000SV X 9%) - (5,000SV X 9%)
 = Rs.1,920 - Rs.450 - Rs.450 - Rs.450
 = Rs.570

Therefore:
Your Group Bonus is Rs.570 and Group Bonus for A, B and C is Rs.450 each.

CASE 2

If YOU have acquired 600PV and each one of your downline achieved 5,000PV:

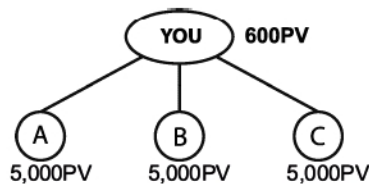

Personal PV/SV (PPV/PSV) = 600PV/SV
 Personal Group PV/SV (PGPV/PGSV) = 15,600PV/SV

You are not qualified to receive any bonus because your Personal PV is less than 1,000PV. To qualify for Group Bonus, YOU must have a minimum of 1,000PV.

"The description of how to achieve Star Diamond in 4 months is for illustration purposes only, and should not be construed in any manner as either representing that a particular individual will be able to achieve such status or that achieving this position is easy. Individual results will vary."

3. Star Group Bonus (25% - 37%)

CASE 1

If YOU are a Star Ruby (SR) and have sponsored 3 Star Agents (SA) and 2 distributors:

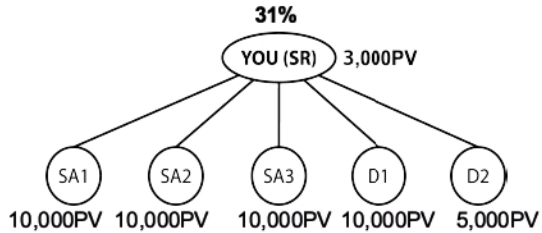

Personal PV/SV (PPV/PSV) = 3,000PV/SV

Personal Group PV/SV (PGPV/PGSV) = 18,000PV/SV

Your Star Group Bonus = (48,000SV X 31%) - (10,000SV X 25%)
 - (10,000SV X 25%) - (10,000SV X 25%)
 - (10,000SV X 12%) - (5,000SV X 9%)
 = Rs.14,880 - Rs.2,500 - Rs.2,500
 - Rs. 2,500 - Rs.1,200 - Rs.450
 = **Rs.5,730**

Therefore:

YOUR Star Group Bonus is Rs.5,730

SA1, SA2 and SA3 will earn Rs.2,500 each.

Group Bonus for D1 is Rs.1,200 and D2 is Rs.450.

CASE 2

If YOU are a Star Diamond with 6 SAs (1st Generation), 3,000PPV and 6,000PGPV. At the same time, YOU have some downlines with the status of Star Ruby (SR) and Star Agent (SA) who have at least 3,000PPV.

The Star Group Bonus entitlement (%) for YOU and your downlines will be as follow:

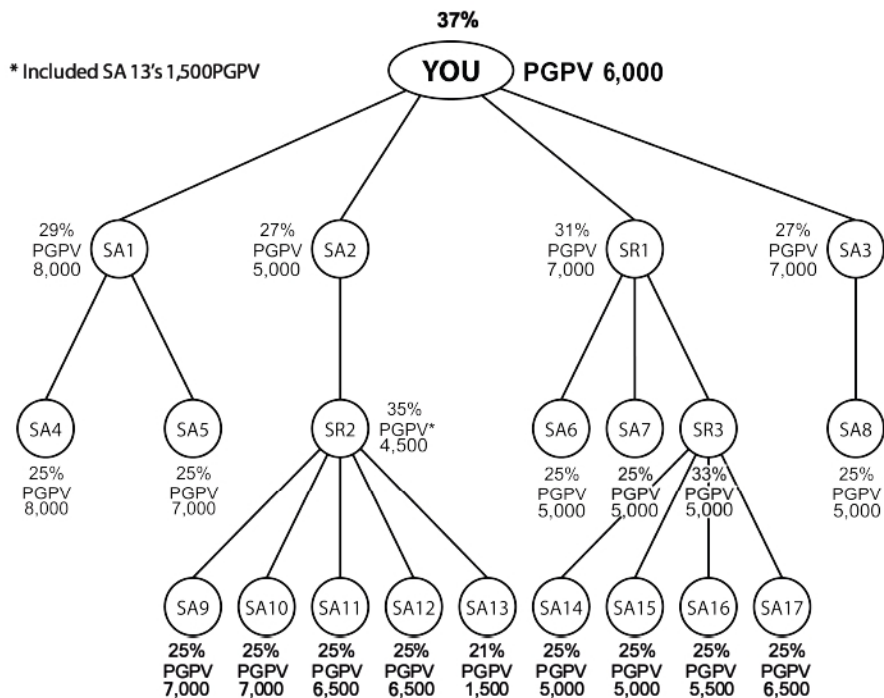

Star Group Bonus (%)

	Status	No of Qualified SA Lines	PPV	PGPV	DGPV	SGB entitlement (%)
YOU	SD	4	3,000	6,000	121,500	37%
SA1	SA	2	3,000	8,000		29%
SA2	SA	1	3,000	5,000		27%
SR1	SR	3	3,000	7,000	44,000	31%
SR2	SR	4	3,000	4,500	31,500	35%
SR3	SR	4	3,000	5,000	27,000	33%
SA4	SA	0	3,000	8,000		25%
SA13	SA	0	1,000	1,500		21%

"The description of how to achieve Star Diamond in 4 months is for illustration purposes only, and should not be construed in any manner as either representing that a particular individual will be able to achieve such status or that achieving this position is easy. Individual results will vary."

CASE 3

If YOU are a Star Ruby (SR) with **5 SAs** (1st Generation), 3,000PPV and 5,000PGPV. At the same time, YOU have downlines with the status of Star Ruby (SR) and Star Agent (SA). Some of the SR or SA are inactive (i.e. SA1, SA2, SA5 & SR)

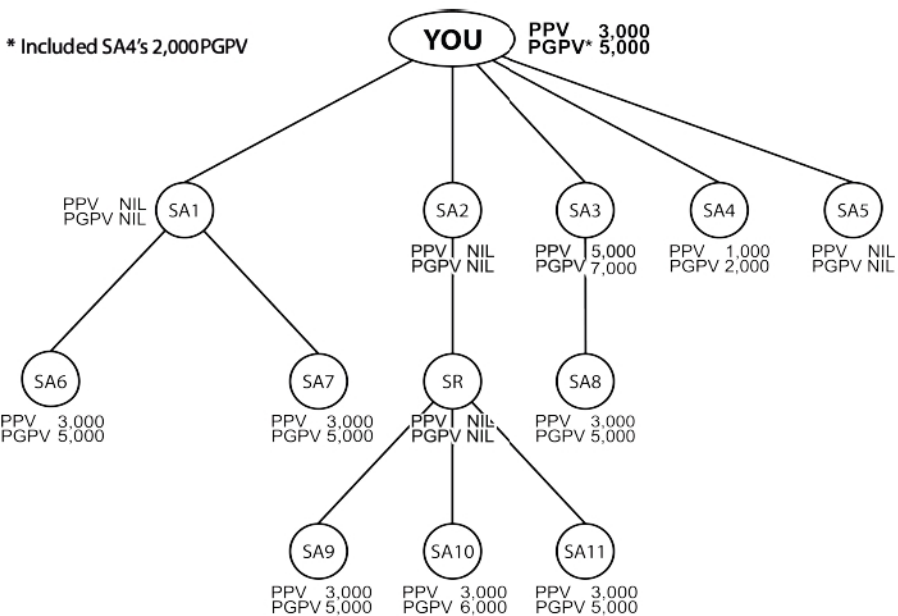

Therefore,

YOU are entitled to 35% of Star Group Bonus even you have only 3 qualified SA lines.

It is because YOU have 5 SAs (1st Generation) and obtained 43,000DGPV.

"The description of how to achieve Star Diamond in 4 months is for illustration purposes only, and should not be construed in any manner as either representing that a particular individual will be able to achieve such status or that achieving this position is easy. Individual results will vary."

4. Development Bonus (15%)

CASE 1

For Development Bonus, if YOU are a Star Ruby (SR) and have downlines as below:

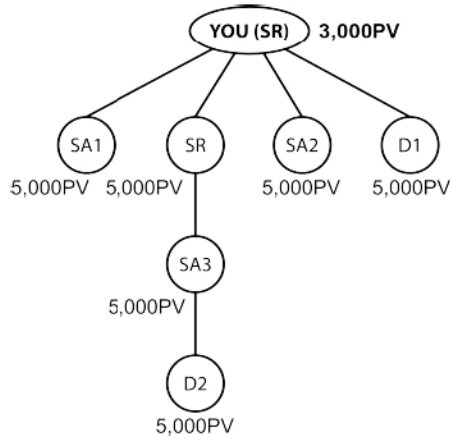

Personal PV/SV (PPV/PSV) = 3,000PV/SV
 Personal Group PV/SV (PGPV/PGSV) = 8,000PV/SV

YOUR Development Bonus = (15,000SV x 5%) + (10,000SV x 4%)
 = Rs.750 + Rs.400
 = **Rs.1,150**

Therefore:

YOUR Development Bonus is Rs.1,150

"The description of how to achieve Star Diamond in 4 months is for illustration purposes only, and should not be construed in any manner as either representing that a particular individual will be able to achieve such status or that achieving this position is easy. Individual results will vary."

CASE 2

For Development Bonus, if YOU are a Star Ruby (SR) and have downlines as below:

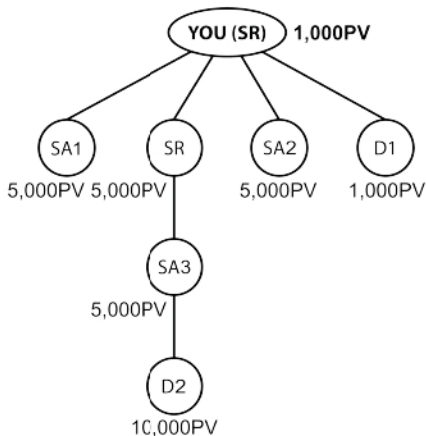

Personal PV/SV (PPV/PSV) = 1,000PV/SV

Personal Group PV/SV (PGPV/PGSV) = 2,000PV/SV

Therefore:

YOU are not qualified to earn the development bonus because your Personal PV is less than 3,000PV.

"The description of how to achieve Star Diamond in 4 months is for illustration purposes only, and should not be construed in any manner as either representing that a particular individual will be able to achieve such status or that achieving this position is easy. Individual results will vary."

5. Group Incentive (2%)



YOU are a Senior Star Diamond (SSD) and have downlines of Star Diamond (SD) and above.

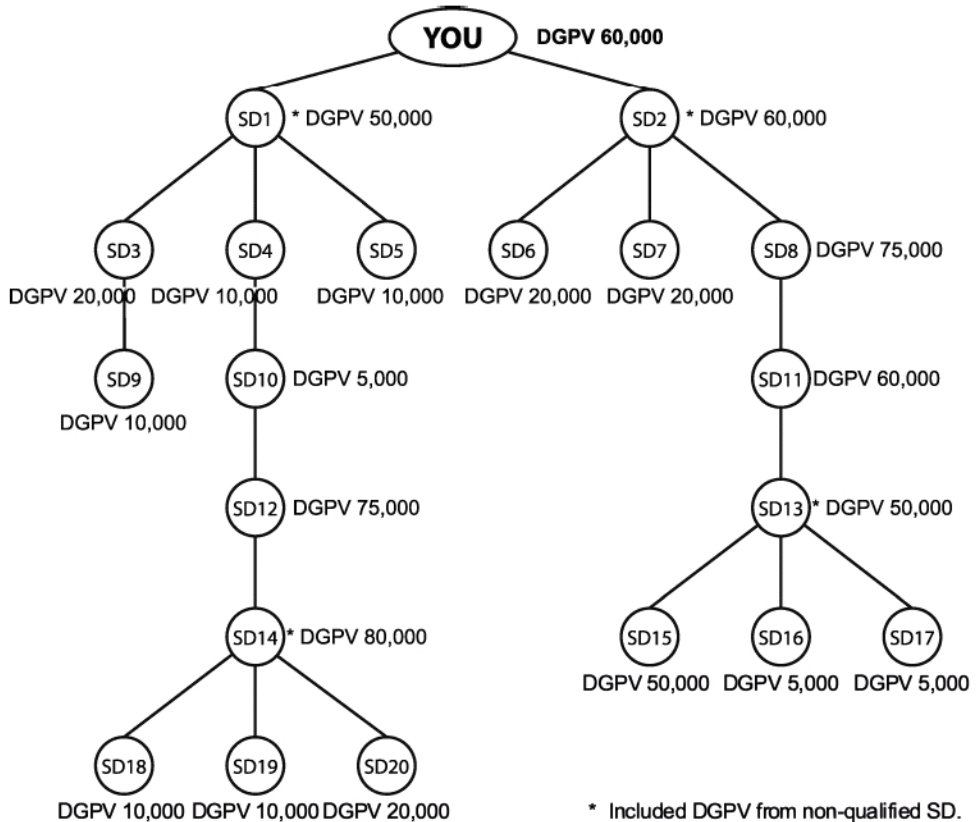

* Included DGPV from non-qualified SD.

Non-qualified SD: SD3, SD4, SD5, SD6, SD7, SD9, SD10, SD16, SD17, SD18, SD19 & SD20
 Qualified SD : YOU, SD1, SD2, SD8, SD11, SD12, SD13, SD14 & SD15

"The description of how to achieve Star Diamond in 4 months is for illustration purposes only, and should not be construed in any manner as either representing that a particular individual will be able to achieve such status or that achieving this position is easy. Individual results will vary."

Assumptions:-

- i) 1PV equals to 1SV.
- ii) There are 68 Star Diamonds and above in the company and the Total GI Point is 5,000,000 points.
- iii) Total company's sales for that particular month is 20,000,000SV.

GI Point for YOU:

	DGSV			GI points
YOU	60,000	X	100%	= 60,000
1st Level: SD1 + SD2	110,000	X	50%	= 55,000
2nd Level: SD12 + SD8	150,000	X	40%	= 60,000
3rd Level: SD14 + SD11	140,000	X	30%	= 42,000
4th Level: SD13	50,000	X	20%	= 10,000
5th Level: SD15	50,000	X	10%	5,000
YOUR Total GI Point				<u>232,000</u>

Therefore:

YOUR Group Incentive

$$\begin{aligned}
 &= \text{GI FUND} \times \frac{\text{Your GI Point for the month}}{\text{Total GI Point for all Qualified Star Diamond \& above}} \\
 &= 2\% \times 20,000,000\text{SV} \times \frac{232,000\text{pts}}{5,000,000\text{pts}} \\
 &= \underline{\underline{\text{Rs.18,560}}}
 \end{aligned}$$

"The description of how to achieve Star Diamond in 4 months is for illustration purposes only, and should not be construed in any manner as either representing that a particular individual will be able to achieve such status or that achieving this position is easy. Individual results will vary."

6. Leadership Bonus (15%)

CASE 1

YOU are an Executive Senior Star Diamond (ESSD) and have qualified for 37% Star Group Bonus.

Every Circle (from A1 to C6) represents a SD and above.

All SDs have qualified for 37% Star Group Bonus.

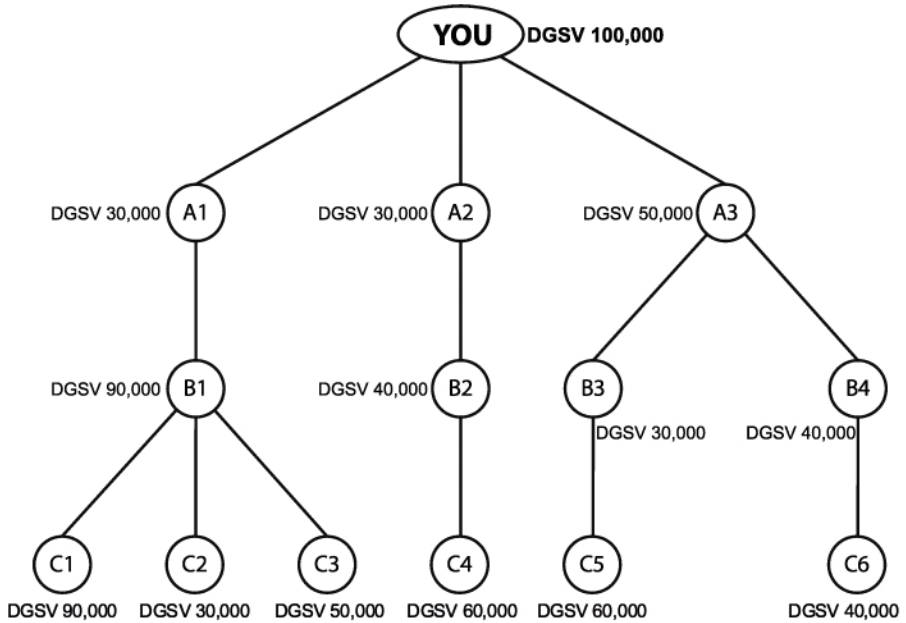

YOUR Leadership Bonus:

1st Level qualified SD:

$$A1 + A2 + A3 = 110,000\text{SV} \times 5.0\% = \text{Rs. } 5,500$$

2nd Level and below qualified SD:

$$B1 + C1 + C2 + C3 + B2 + C4 + B3 + B4 = 430,000\text{SV} \times 4.8\% = \text{Rs. } 20,640$$

$$C5 + C6 = 100,000\text{SV} \times 1.8\% = \text{Rs. } 1,800$$

YOUR Leadership Bonus

Rs.27,940

"The description of how to achieve Star Diamond in 4 months is for illustration purposes only, and should not be construed in any manner as either representing that a particular individual will be able to achieve such status or that achieving this position is easy. Individual results will vary."

CASE 2

YOU are an Executive Double Diamond (EDD) and have qualified for 37% Star Group Bonus. Every Circle (from A1 to C6) represents a SD and above. All SDs have qualified for 37% Star Group Bonus with the exception of A1, A2, A5, & B5.

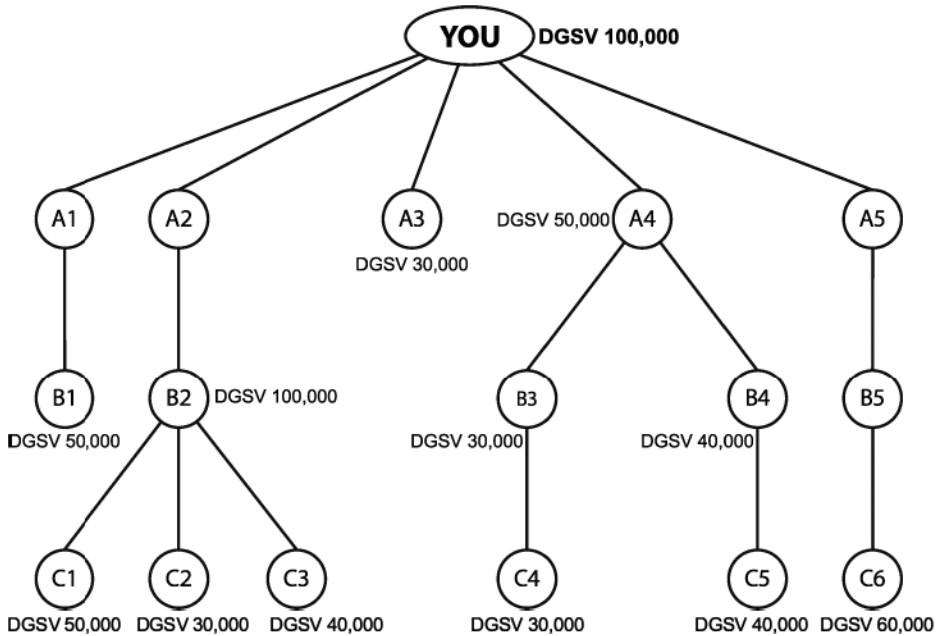

YOUR Leadership Bonus:

1st Level qualified SD:

$$B1 + B2 + A3 + A4 + C6 = 290,000\text{SV} \times 5.0\% = \text{Rs.14,500}$$

2nd Level and below qualified SD:

$$C1 + C2 + C3 + B3 + B4 = 190,000\text{SV} \times 6.5\% = \text{Rs.12,350}$$

$$C4 + C5 = 70,000\text{SV} \times 3.5\% = \text{Rs. 2,450}$$

YOUR Leadership Bonus

Rs.29,300

"The description of how to achieve Star Diamond in 4 months is for illustration purposes only, and should not be construed in any manner as either representing that a particular individual will be able to achieve such status or that achieving this position is easy. Individual results will vary."

CASE 3

YOU are an Executive Double Diamond (EDD) and have qualified for 37% Star Group Bonus. Every Circle (from A1 to C6) represents a SD and above. All SDs have qualified for 37% Star Group Bonus with the exception of A1, A2, A5, & B5.

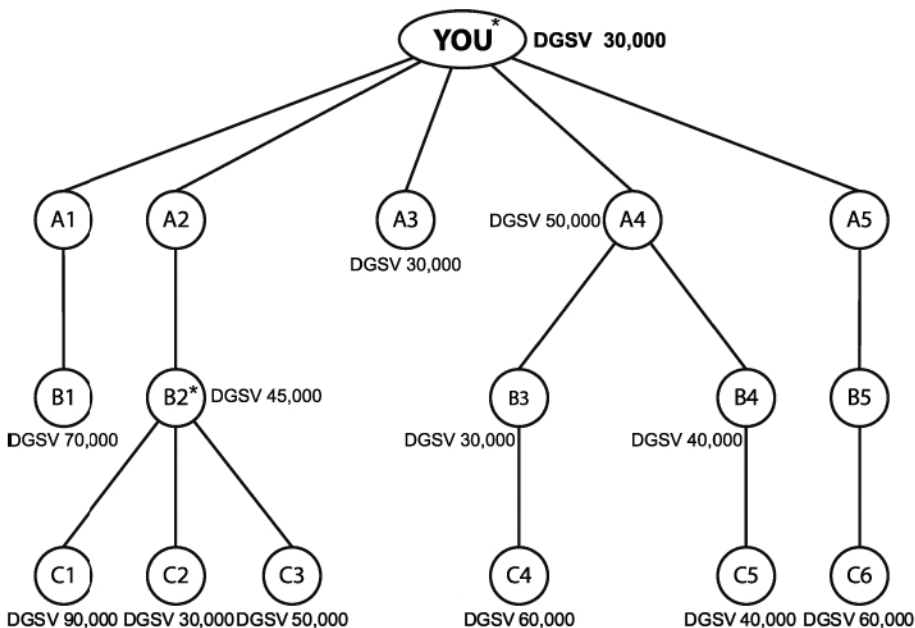

YOUR Leadership Bonus:

1st Level qualified SD:

B1 + B2 + A3 + A4 + C6

255,000SV

Add: Guarantee from Downline (B2)

30,000SV

Less: Guarantee Upline (YOU)

(70,000SV)

215,000SV X 5.0% = Rs.10,750

2nd Level and below qualified SD:

C1 + C2 + C3 + B3 + B4

240,000SV

Less: Guarantee Upline (B2)

(30,000SV)

210,000SV X 6.5% = Rs.13,650

C4 + C5

100,000SV X 3.5%

= Rs. 3,500

YOUR Leadership Bonus

Rs.27,900

* YOU need to guarantee upline 100,000DGSV.

* B2 need to guarantee upline 75,000DGSV.

"The description of how to achieve Star Diamond in 4 months is for illustration purposes only, and should not be construed in any manner as either representing that a particular individual will be able to achieve such status or that achieving this position is easy. Individual results will vary."

CASE 4

YOU are a Crown Ambassador (CA) and have 20 first generation Crown Ambassadors (CAs) with 100,000DGSV each. All CAs have 20 Qualified SDs with 100,000DGSV each.

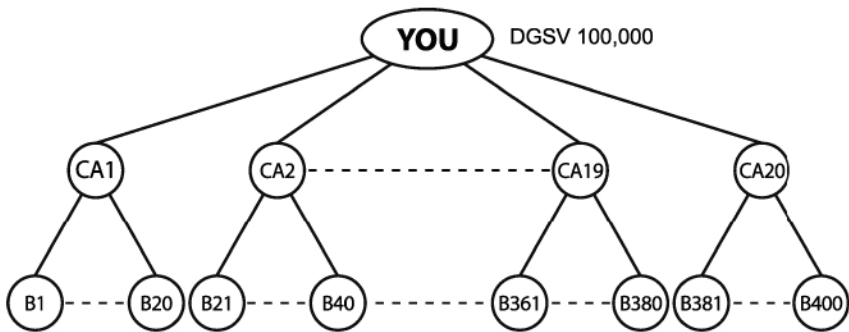

Therefore:

Your Leadership Bonus

$$1\text{st Level Qualified SD: } 100,000\text{DGSV} \times 20 \times 5\% = \text{Rs. } 100,000$$

$$2\text{nd Level Qualified SD: } 100,000\text{DGSV} \times 400 \times 10\% = \text{Rs. } 4,000,000$$

Rs.4,100,000

"The description of how to achieve Star Diamond in 4 months is for illustration purposes only, and should not be construed in any manner as either representing that a particular individual will be able to achieve such status or that achieving this position is easy. Individual results will vary."

7. One Time Hand Phone Cash Incentive



After you have sponsored 3 immediate SAs who achieved 60,000 Accumulated GPV.

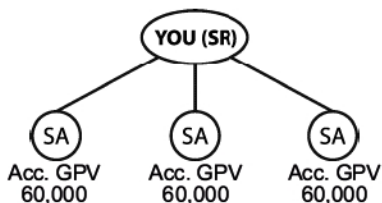

Therefore:

YOU are qualified to receive the One Time Hand Phone Cash Incentive amounting to Rs.15,000.

8. One Time Overseas Trip Cash Incentive



After you have 5 immediate downlines who have received their Hand Phone Cash Incentive, then you are qualified for this One Time Overseas Trip Cash Incentive.

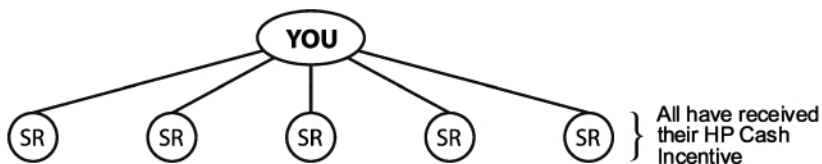

Therefore:

Once YOU have fulfilled the requirements, YOU are qualified for One Time Overseas Trip Cash Incentive amounting to Rs.120,000.

"The description of how to achieve Star Diamond in 4 months is for illustration purposes only, and should not be construed in any manner as either representing that a particular individual will be able to achieve such status or that achieving this position is easy. Individual results will vary."

How to become a Star Diamond within 4 months

Assumptions:-

- Personal Sales for each distributor is 3,000PPV per month.
- Each distributor sponsors 3 new distributors in each month.
- 1PV = 1SV

1st Month

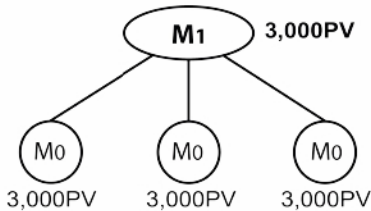

Your status : Distributor - 12,000PGPV (12%)

Personal PV/SV (PPV/PSV) = 3,000PV/SV
 Personal Group PV/SV (PGPV/PGSV) = 12,000PV/SV
 Accumulated GPV = 12,000PV

Your Bonus Income			
Group Bonus	=	12,000SV X 12%	= Rs.1,440
Less: Downlines Bonus	=	(3,000SV X 9% X 3)	= (Rs.810)
YOUR Bonus Income			<u>Rs.630</u>

"The description of how to achieve Star Diamond in 4 months is for illustration purposes only, and should not be construed in any manner as either representing that a particular individual will be able to achieve such status or that achieving this position is easy. Individual results will vary."

2nd Month

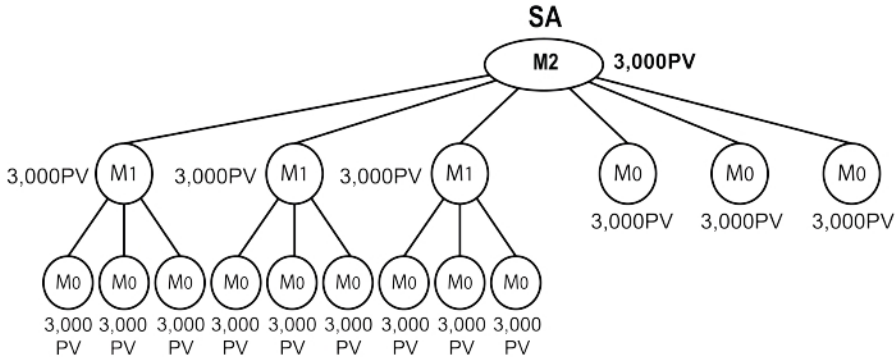

Congratulations! You have reached more than 45,000 Accumulated GPV and you are now a Star Agent.

Your status: Star Agent - Accumulated 60,000GPV (25%)

Your status : Distributor - Accumulated 20,000 PGPV (15%)

Personal PV/SV (PPV/PSV) = 3,000PV/SV
 Personal Group PV/SV (PGPV/PGSV) = 48,000PV/SV
 Accumulated GPV b/f = 12,000PV
 Accumulated GPV cff = 60,000PV

Your Bonus Income		
Star Group Bonus	= 48,000SV x 25%	= Rs.12,000
Less: Downlines Bonus	= (12,000SV x 12% x 3)	
	+ (3,000SV x 9% x 3)	= (Rs.5,130)
YOUR Bonus Income		<u><u>Rs.6,870</u></u>

"The description of how to achieve Star Diamond in 4 months is for illustration purposes only, and should not be construed in any manner as either representing that a particular individual will be able to achieve such status or that achieving this posit on is easy. Individual results will vary."

3rd Month

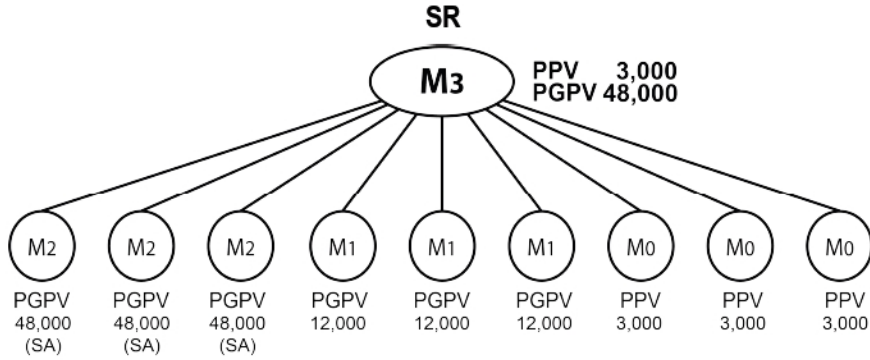

Congratulations! You have successfully promoted 3 direct Star Agent under you, and therefore you are now a Star Ruby.

Personal PV/SV (PPV/PSV) Personal = 3,000PV/SV
 Group PV/SV (PGPV/PGSV) = 48,000PV/SV

Diamond Group PV/SV (DGPV/DGSV) = 192,000PV/SV

Your Bonus Income

(A) Star Group Bonus = 192,000SV X 31% = Rs.59,520
 Less: Downline Bonus = (48,000SV X 25% X 3)
 + (12,000SV X 12% X 3)
 + (3,000SV X 9% X 3) = (Rs.41,130) = **Rs.18,390**

(B) Development Bonus
 1st level QSA = 48,000SV X 3 X 5% = **Rs.7,200**

(C) HP Cash Incentive = **Rs.15,000**

YOUR Bonus Income = Rs.40,590

"The description of how to achieve Star Diamond in 4 months is for illustration purposes only, and should not be construed in any manner as either representing that a particular individual will be able to achieve such status or that achieving this position is easy. Individual results will vary."

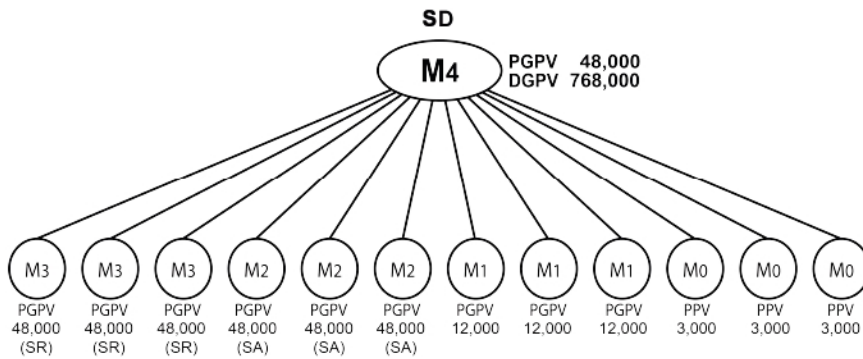

Congratulations! You have successfully promoted 6 SA (1st Generation) and have also met the 25,000DGPV quota. Hence you are now a Star Diamond.

Personal PV/SV (PPV/PSV) = 3,000PV/SV
 Personal Group PV/SV (PGPV/PGSV) = 48,000PV/SV
 Diamond Group PV/SV (DGPV/DGSV) = 768,000PV/SV

Your Bonus Income

(A) Star Group Bonus = 768,000SV X 37% = Rs.284,160
 Less: Downline Bonus = (192,000SV X 31% X 3)
 + (48,000SV X 25% X 3)
 + (12,000SV X 12% X 3)
 + (3,000SV X 9% X 3) = (Rs.219,690) = **Rs.64,470**

(B) Development Bonus
 1st level QSA = 48,000SV X 6 X 5% = Rs.14,400
 2nd level QSA = 48,000SV X 9 X 4% = Rs.17,280 = **Rs.31,680**

(C) International Profit Sharing

Assumption: -

i) IPS Fund = Rs.400,000
 ii) Total IPS Point for all Qualifiers = 50,000,000pts
 iii) YOUR IPS Point for the month = 768,000SV X 100%
 = 768,000pts

Your International Profit Sharing

=Rs.400,000 X 768.000pts =Rs.6,144
 50,000,000pts

YOUR Bonus Income

= Rs.102,294

"The description of how to achieve Star Diamond in 4 months is for illustration purposes only, and should not be construed in any manner as either representing that a particular individual will be able to achieve such status or that achieving this position is easy. Individual results will vary."

Distributorship Rules and Regulations

Definition :

For the purposes of the DXN MARKETING INDIA PVT. LTD. Rules and Regulations, unless the context otherwise requires or unless repugnant to or inconsistent with such context, the following words or expression shall have the following meanings :

"Distributor"

Shall mean for the purpose of the DXN MARKETING INDIA PVT. LTD. Distributorship Rules and Regulations, a person who has applied under clause-1 herein and whose application has been accepted by DXN.

"DXN" shall mean

DXN MARKETING INDIA PVT. LTD.

"PV"

shall mean "point value" as ascribed to DXN products and for qualification and status

"PPV"

shall mean "Personal Point Value", i.e total PV generated from all personal cash bills transacted in a month

"Product" or "Products"

shall mean products or produced distributed by DXN, or which bears the DXN label, Logo or Name

"SCN"

shall mean Show Cause Notice

"Sponsor"

shall mean an existing distributor who after fulfilling the eligibility criteria of a sponsor, introduces a prospect to be a Distributor of DXN and whose name appears on the new Distributor's Application and Enrollment form bearing a unique ID number, as Sponsor.

"SV"

shall mean "Sales Value", as ascribed to DXN products for bonus and incentives

Unless the context otherwise requires or unless repugnant or inconsistent with such context, the following interpretation shall apply :-

- (a) References to clauses and sub clauses are to be construed as references to clauses of this DXN Distributorship Rules and Regulations;
- (b) References to DXN Distributorship Rules and Regulations Code of Conduct DXN Marketing plan and any of its policies, central or state legislation or provisions of such legislation shall include such provisions as modified, amended or re-enacted;
- (c) References to persons include anybody corporate or partnership;
- (d) Words denoting the masculine gender include the feminine and neuter genders and vice versa ;

- (e) Words denoting the singular number include the plural number and vice versa ;
- (f) The headings to the clauses are for ease of reference only and shall not affect the interpretation of the DXN Distributorship Rules and Regulations; and
- (g) References to any party includes its successors in title and permitted assigns.

1. Application for Distributorship:

1.1. Only applicants aged 18 years and above may apply to become as a Distributor.

1.2. In order to become a Distributor of DXN, an applicant is required to complete and sign the Distributorship Application form and shall irrevocably agree to abide by the DXN Distributorship Rules and Regulations, Code of Conduct, DXN Marketing plan and any of its policies including but not limited to any variation, amendment or modification. Any application for distributorship is subject to the approval of DXN. The completed form can be handed over to the Stockist, branch or head office where registration receipt and temporary card will be issued.

1.3. A Distributor is prohibited from submitting any false or inaccurate information to DXN. A Distributor shall inform DXN of any changes affecting the accuracy of the Distributor's details. DXN reserves the right to immediately terminate any Distributorship in the event it determines that false or inaccurate information was provided by the said Distributor.

2. Status of Distributorship:

2.1. Application can be submitted for the following status:

- (a) Husband and wife are automatically deemed to be registered as joint Distributors with a single Distributorship code. If the husband or wife is found to have registered as a Distributor of DXN after the spouse has earlier been a Distributor of DXN, then the later registration of Distributorship will be cancelled and / or the whole group will be transferred to the spouse. However, in the event of a couple married after both of their joining dates, they are allowed to hold two separate Distributorship codes.
- (b) A corporation cannot be accepted as a Distributor of DXN. Nevertheless, if a Distributor wishes to change his Distributorship to a private company or a partnership, written approval from DXN shall be obtained. In the event DXN has approved the Distributorship application by a corporation or private company or partnership etc., any change to the equity structure, done without the approval of DXN, DXN reserves the right to forthwith terminate the Distributorship.
- (c) Taking of multiple Distributorship in same name / proxy identity is strictly prohibited. Every applicant for Distributorship is required to tender / attach their photo identity proof along with the application.

3. Conditional Life Distributorship:

3.1. Distributorship with DXN is for a lifetime and no yearly renewal of Distributorship is necessary PROVIDED THAT the Distributor makes at least one (1) personal purchase transaction with PV in each calender year. Personal purchase transaction refers to purchase of DXN product(s) with PV, regardless of amount, made in the Distributor's own name.

3.2. Failure to comply with the above requirement shall render the distributorship of the concerned distributor to lapse on 31st December of respective calender year without further notice. Any reinstatement may be done between 1st January until 31st March in the same calender year of expiry in a single cash bill subject to the following :

- (a) the minimum monthly PPV required for bonus has been achieved by the Distributor; and
- (b) the reinstatement is approved by DXN

3.3. For new distributors joining between 1st October and 31st December, the expiry date shall be extended until 31st December of the following year.

3.4. Distributor whose distributorship has lapsed may re-register as a new Distributor under the same or another Sponsor; however, he will be considered and deemed as a new Distributor and therefore, not entitled to his former network.

3.5. The reinstatement would be effective upon due approval from DXN Management. In other words, the reinstatement would not be backdated. Purchases, if any, made after lapse of distributorship would be accumulated and encoded according to the Marketing plan in the month of reinstatement.

3.6. A Distributor who fails to reinstate his distributorship within the above-said grace period may not be entitled to reinstate his former network upon their re-registration after the grace period.

3.7. A Distributor's distributorship shall be terminated if he (or any one of the spouse / partner / party / member of the company including proxy) is directly or indirectly involved in any of the disciplinary cases such as:

- (a) sponsoring other Distributors in an improper / invalid manner;
- (b) changing the selling price of a product without obtaining prior approval of DXN;
- (c) other direct sales companies or any company having competition with DXN;
- (d) breach of DXN Rules and Regulations, code of conduct, DXN Marketing plan or any of its policies;
- (e) conducting any activities that directly or indirectly will bring negative effects to DXN or affect DXN goodwill;
- (f) delivering, distributing or selling DXN's products of one country to another country (in which DXN's market has been established) without written approval from DXN;
- (g) making false claims relating to the products or the DXN Marketing plan.

4. Registration Fee:

The registration fee for taking distributorship is determined by DXN which is subject to change on issuance or announcement of any notice and takes effect immediately. Presently the registration of Distributorship is free of any charge. An Interested prospect need to fill in and submit the completed Direct Seller Application and Agreement form to any DXN authorized outlet. On acceptance of the completed application form, the applicant will be enrolled as an Independent Distributor of DXN with an unique identity code (ID).

5. DXN Starter Kit:

Every distributor is encouraged to purchase the Starter kit / DXN Business Manual in their own interest to learn the distributorship norms and promote the business in an ethical, efficient and productive manner with full knowledge of the company, products and services offered.

6. Distributor's Purchase Order:

Products can be purchased by cash (or by any mode of payment so accepted by DXN) from DXN sales outlets and its valid stockist. Cash bill will be issued for each private purchase of Distributor. All purchases after the month end cannot be backdated from the date of purchase.

7. Entitlement to Monthly Bonus:

7.1. A Distributor is required to maintain a monthly PPV exclusively in one (1) country for bonus qualification and commissions overriding. Bonuses are paid according to DXN Marketing plan when and where a Distributor has maintained the required monthly PPV.

7.2. In addition, DXN reserves the right to recoup any bonuses paid to any Distributor on products or services under the following circumstances :

- (a) returned under DXN's buy back policy or expectations thereto established by an authorized stockist;
- (b) returned to an authorized stockist under any applicable law; or
- (c) stolen or obtained by fraudulent means.

8. Discrepancy in monthly Bonus statement:

DXN shall be informed in writing within thirty (30) days from the date of receipt of the monthly bonus statement of any discrepancy in the said statement after which at the end of the specified time period, all monthly bonus statement shall be deemed as final and conclusive and DXN shall not entertain any inquiry or complaint.

9. Suspension and Termination of Bonuses, Incentives and Benefits :

DXN reserves the full and absolute right, at any point of time, to withhold or suspend or terminate a Distributor's benefits including but not limited to bonuses, incentives, commissions, entitlements, etc., in the event :

- 9.1. A Distributor has been issued with a SCN for violating any provisions of the DXN Distributorship Rules and Regulations, Code of Conduct, DXN Marketing plan or any of its policies; or
- 9.2. A Distributor who is currently in the process of due inquiry conducted by DXN or allegedly violating any provisions of the DXN Distributorship Rules and Regulations, Code of Conduct, DXN Marketing plan or any of its policies; or
- 9.3. A Distributor who has been found liable by DXN for violating any provisions DXN Distributorship Rules and Regulations, Code of Conduct, DXN Marketing plan or any of its policies; or
- 9.4. Pending the finalization of transfer of the Distributorship to beneficiary; or
- 9.5. Any other causes / reasons deems necessary and fit by DXN.

10. Responsibilities of a Distributor:

- 10.1. A Distributor is independent and is free to operate on his own. Therefore, a Distributor shall not claim or represent as an employee or having employment representing himself as such.
- 10.2. A Distributor shall represent the products, services and opportunity of becoming a Distributor ethically and professionally.
- 10.3. No representation or sales offers may be made relating to products and services, which are inaccurate as to price, grade, quality and liability.
- 10.4. No unreasonable, misleading, or unrepresentative earnings claims may be made. No income guarantees of any kind shall be made.
- 10.5. A Distributor may not solicit or persuade any other Distributor to sell or purchase products or services other than those offered by DXN. A Distributor agrees that a violation of this rules inflicts irreparable harm to DXN and agrees that injunctive relief is an appropriate remedy to prevent it.
- 10.6. A Distributor is responsible for his own business decisions and expenditures.
- 10.7. A Distributor shall comply fully with the DXN Distributorship Rules and Regulations, Code of Conduct, DXN Marketing plan or any of its policies.
- 10.8. A Distributor is personally responsible and accountable for compliance with all applicable national, state, municipal and local laws and regulations.
- 10.9. A Distributor shall comply with all laws, regulations and codes of practice applying to the operation of his Distributorship and shall not engage in any activity which may bring disrepute to themselves or to DXN.
- 10.10. A Distributor shall not make any representation to a prospective recruit and / or customer which cannot be verified or make any promise which cannot be fulfilled. A Distributor shall not present any information to the customer / prospect in a false or deceptive manner.

11. Restriction / Right to Area :

- 11.1. A Distributor is not allowed to have any right or impose any restriction to a particular area and are strictly prohibited to declare that they have any specific right on a particular area.
- 11.2. A Distributor is strictly prohibited to distribute or sell any DXN products, specifically manufactured for a particular country, in any other country unless written approval from DXN.

12. Restriction on products :

12.1. DXN Products are strictly prohibited from being sold or exhibited in grocery shops, stores, mini-markets, supermarkets, military stores or trade fair, online e-commerce websites.

13. Manner of selling and selling price :

13.1. The selling price of any DXN product is determined by DXN and no Distributor shall be allowed to reduce or increase the price including by way of tampering the selling price as affixed or determined by DXN on the label or packaging of the product. Breach of this regulation shall result in having Distributorship suspended or terminated by DXN.

13.2. DXN reserves the right, at any point of time to revise the selling price including but not limited to PV and SV of the product without any prior notice, and the revised price so determined or fixed shall have immediate effect upon its official announcement.

13.3. A Distributor is not allowed to deliver, Distribute or sell any products by way of discounts, free gifts, promotion that in aggregate or in any how are confirming the products are distributed or sold below or above the selling price so determined and permitted by DXN, unless the discounts, free gifts or promotion is organized and approved by DXN.

13.4. A Distributor is required to sell products to end users / consumers only under valid customer receipt wherein details of the sales transactions are mentioned along with the product refund policy / buyback guarantee provided by the company. Such receipt book in prescribed formats are available at the authorized sales outlets. Distributors have the option to print their own Receipt Book in the same format / template as made available by the company.

14. Product Claims :

14.1. A Distributor shall be held liable and responsible for false claims, misrepresentation etc., of the product quality, quantity, content, usage or benefits other than those mentioned in authorized product literature specified by DXN and all such acts shall lead to disciplinary action including suspension or termination of Distributorship.

14.2. No Distributor should or attempt to state or intimate that any product is approved by or bears special sanction of the ministry of a health or any other Governmental authority.

15. Improper sponsoring of Distributor and penalty:

15.1. Improper sponsoring : Improper way of sponsoring Distributors in the following context are prohibited :-

- (a) Sponsoring a Distributor who is already a Distributor of another group;
- (b) Sponsoring the spouse of a person who is already a Distributor of another group.

15.2. The following actions will be taken if improper sponsoring is proven to have occurred :

- (a) Distributorship shall be terminated with immediate effect. If the Distributorship is terminated, all Distributors who were improperly sponsored will be transferred to their original sponsors.
- (b) If the spouse (B) of Distributor (A) is found to have become a Distributor of another group, B's Distributorship will be terminated immediately and Distributors under B will be transferred to A.
- (c) Penalty letters will be issued to all those who are involved.
- (d) No arrears of bonus will be considered.

15.3. Proxy and its Penalty:

If a Distributor establishes a group not under his hierarchy but has self-interest in the development of the group, the Distributor is deemed to have been involved in this activity and his Distributorship will be suspended or terminated and the group established by Proxy will be transferred to the Sponsor.

16. Involvement in other Direct Sales Company:

16.1. A Distributor who has achieved the status of Star Ruby and above is not allowed to be involved directly or indirectly (including by Proxy) in any activities of other direct sales companies or other activities that will bring negative effects to DXN. Any Distributor who commits such offence shall have his Distributorship terminated immediately by DXN.

16.2. A Distributor shall not directly or indirectly and whether on his own behalf or with or for any other person solicit, promote or recruit any member of their downline organization to join or participate in any other direct selling or network marketing business or to distribute, sell or promote any products or services competitive with DXN.

17. Breach of the DXN Distributorship Rules and Regulations, Code of Conduct, DXN Marketing plan and any of its policies.

17.1. If a Distributor breaches any provisions of the DXN Distributorship Rules and Regulations, Code of Conduct, DXN Marketing plan or any of its policies, the Distributor's Distributorship may be suspended or terminated immediately.

17.2. During the period of DXN investigation or issuance of SCN or suspension notice for the alleged violation of the DXN Distributorship Rules and Regulations, Code of Conduct, DXN Marketing plan or any of its policies, the following shall be applied:

- (a) DXN may provide verbal warning or issue a warning notice to the Distributor for the violation of the DXN Distributorship Rules and Regulations, Code of Conduct, DXN Marketing plan or any of its policies;
- (b) In the event of a SCN is issued to a Distributor, the Distributor shall within fourteen (14) days from the date of the same provide his written explanation relating to the allegations for consideration by DXN. DXN reserves the right to suspend the said Distributor from participating or carrying out activities which includes but not limited to placing orders, making sales or purchase, dealing with DXN's products, dealing with networks, sponsoring, modifying Distributors information, attend training, participate in DXN's activities, participate in promotional activities or incentive campaigns, receiving bonuses, commissions or incentives until a final decision is made by DXN.

- (c) In the event of the Distributor failing to provide any written reply to the said SCN within the said period, DXN shall have the right to impose such action as it considers proper.
- (d) On the basis of any information obtained from collateral sources or from DXN's investigation of the statements and facts taken together with information submitted to DXN during the response period, DXN shall make a final decision regarding the appropriate remedy, which includes the termination of the DXN's Distributorship. DXN reserves the right to impose any remedies for similar violations of DXN Distributorship Rules and Regulations, Code of Conduct, DXN Marketing plan or any of its policies on a case-by-case basis. DXN will notify the Distributor of its decision and all remedies will be effective forthwith as of the date on which notice of DXN decision is served.
- (e) In the event of termination of the Distributor's Distributorship, the Distributor's Distributorship / status and all benefits pursuant to the DXN Marketing plan including but not limited to benefits on promotion activities, incentive campaigns, entitlements shall be forfeited. Henceforth, the terminated Distributor is automatically prohibited from dealing in whatsoever manner with DXN's products, networks and activities.
- (f) Any Distributor so terminated may apply for new Distributorship from DXN after a period of six (6) months. However, acceptance of the application is subjected to the verification and approval by DXN.

18. Beneficiary :

18.1. A Distributor may appoint any person of the same nationality as his beneficiary. If no beneficiary is named in the Distributorship form, the beneficiary shall be the next of kin. However if there is a dispute relating to the beneficiary after the death of a Distributor, the appropriate court shall decide the beneficiary. DXN reserves the right to suspend any benefits including but not limited to bonuses and commissions until a final decision is made by the court.

18.2. A Distributor shall not transfer, allocate, or otherwise transfer any right conveyed under his Distributorship to any person without the written approval from DXN. A Distributor may delegate his responsibilities but he is ultimately responsible for ensuring compliance with the applicable laws and regulations.

19. Properties of DXN :

19.1. DXN logos, trademarks, service marks, product names, and other tangible or intangible commercial assets, registered or otherwise, e-materials, stationeries, printed materials, provided and related to DXN are the properties of DXN. They are not to be used, extracted or reproduced by any Distributor without prior written approval from DXN.

19.2. All promotional materials including but not limited to flyers, business cards, pamphlets, brochures, books prepared by DXN, may be distributed through personal contact only. They may not be posted in public places, mass mailed, put in mail boxes, or disseminated by any other non-personal contact means. Materials may not be disseminated through unsolicited fax or E-mail message.

20. Distributor Agreement:

An Agreement between a Distributor and DXN takes effect as soon as the Distributorship is approved by DXN.

21. Transfer of Distributorship :

Transfer of Distributorship is divided in two categories;

21.1. Death

If a Distributor passes away, the beneficiary will automatically take over the Distributorship. If no beneficiary is named, the transfer of Distributorship will be determined as per the law prevailing in the Country. Simultaneously, DXN reserves right to suspend any and all benefits including but not limited to bonuses, commissions until the issue is resolved.

21 .2. Indisposition

A Distributor who has reached the age of 65 years or unable to continue the DXN business due to health complications which, if accepted by DXN shall be allowed to transfer the Distributor to anyone as he wishes or to his beneficiary.

22. Double Registration :

22.1. A married couple at the point of registration as DXN Distributor shall be given a common code, that means a single DXN Distributorship entity, thus, at any one moment, a registered DXN Distributor with a married status is prohibited to apply or acquire an additional new Distributorship under his own or under his spouse name.

22.2. In the event that a double registration has been detected and confirmed as such, DXN reserves the right and shall terminate the newer Distributorship code with immediate effect without further reference or notice. Accordingly, DXN shall transfer all the newer Distributorship code's downlines and accumulated PVs to the old Distributorship code.

22.3. Disciplinary action such as suspension or termination shall be initiated against any Distributor or Sponsor who is directly, indirectly or accidentally found to be involved in double registration .

23. Request for Changing Sponsors:

23.1. Application for change of Sponsor is not allowed by DXN.

23.2. If a Distributor insists on changing his Sponsor, he can write to DXN to terminate his existing Distributorship and wait for six (6) months before re-applying for Distributorship under a new Sponsor.

23.3. For a Distributor whose Distributorship has lapsed may request to change his Sponsor by re-registering as per following the procedure stated in Clause 3.

23.4. A Distributor shall not directly or indirectly encourage, persuade, involve or assist another Distributor to transfer to a different Sponsor. This includes the act of offering financial or other tangible or intangible incentives or benefits to induce the Distributor to terminate his existing Distributorship and then re-register under a different sponsor. Any Distributor found liable to be involved in such practice may result in his Distributorship to be suspended or terminated immediately.

24. Buy Back Policy :

24.1. DXN practices Buy Back Policy to ensure maximum satisfaction to its end users / consumers or Distributors. This policy allows every Distributor or consumer to return unsold DXN Products in its original condition and of merchantable quality within 30 days from the date of purchase to the seller. Product in the "original condition and of merchantable quality" means the products which are still in market, with price label intact and clean, unopened box and in good condition. The Distributor must fill the Distributor buy back forms and submit the same to any of the DXN offices, outlets or branches under acknowledgement. DXN reserves the right to reject any returned product that does not meet such specification or condition.

24.2. Distributors on resignation / termination of Distributorship are entitled to return all unsold products purchased by them during the preceding Six months prior to resignation as long as the said products are in sealed condition, merchantable quality and within reasonable shelf life, as determined by DXN.

24.3. DXN reserves the right to deduct any bonus paid on the product returned to it by its Distributors to the extent it has been paid / enjoyed by the said Distributor who returns the products. Otherwise, the bonus paid on the returned products will also be recovered from the other Distributors who have enjoyed the same.

24.4. Products returned should be accompanied with the following documents :

- (a) Relevant cash bills / invoices (only original copy is considered valid);
- (b) Filled in Buyback form

24.5. DXN will send the full refund against the product returned by a crossed cheque / fund transfer to Bank Account subject to any deduction mentioned under Clause 24.3. The cheque / fund transfer will be made within Thirty(30) days from the returned date.

24.6. Distributors are advised not to over purchase. Purchase of Products should be made on realistic estimation of the customer's order.

25. Distributor Website Regulations:

25.1. Any Distributor who wish to establish link to DXN website or any of its subsidiary companies must submit application, stating its purpose and be approved by DXN prior to posting the link.

25.2. No site references DXN, its Products or link to DXN or DXN website to make unsubstantiated income or Product claim.

25.3. No site should make it appear that it is DXN subsidiary or that the site is in any way sanctioned or endorsed by DXN.

25.4. All sites linked to DXN or any of its subsidiary companies must clearly state in a highly visible location that they are operated by independent Distributor.

25.5. The Distributor's website must not display DXN logo, trademark, or its Products. Any text related to or describing the link to DXN website or any of its subsidiary companies must be in strict accordance with specifications approved by DXN.

25.6. A Distributor is fully responsible, accountable and liable for any misuse or misrepresentation of the website. Any violation of this clause and its sub-clauses thereto shall lead to disciplinary action such as suspension or termination of the Distributor's Distributorship.

26. Promotion Activities and Incentives Campaigns :

26.1. Distributors shall abide with the respective rules and regulations governing all promotion activities and incentives campaigns.

26.2. At any point of time of the promotion activities or incentive campaigns, if any Distributor is under investigation for disciplinary cases or has been or about to be issued a SCN for violation of DXN Distributorship Rules and Regulations, DXN reserves the absolute right, at any point of time, to suspend or disqualify any Distributor from any and all promotion activities or incentive campaigns.

27. Litigation and claims:

In the event any Distributor is charged with any infringement of any, proprietary right of any 3rd party arising from any DXN proprietary assets, or if the Distributor becomes the subject of any claim or suit related to that Distributor's business-related conduct or any other action that directly or indirectly negatively affects or puts DXN, its reputations, or any of its tangible or intangible assets at risk, the affected Distributor shall immediately notify DXN. DXN may, at its own expenses and upon reasonable notice, take whatever action it deems necessary (including, but not limited to, controlling any litigation or settlement discussion related thereto) to protect itself, its reputations, and its tangible and intangible property. A Distributor shall take no action related to that claim and suit, unless obtained DXN's written consents.

28. General Business Ethics :

28.1. A Distributor agrees that he shall not make any misleading, unfair, inaccurate, or disparaging comparisons, claims, representations, or statements about DXN its products, services, or commercial activities; other persons other companies (including competitors); their products; or their commercial activities.

28.2. A Distributor agrees that any claim or representation concerning the opportunity must be congruent with, and limited to those found in the materials and literature currently distributed by DXN. Those claims and representations must also be advanced in accordance with any applicable laws, ordinances and regulations, etc.

28.3. No Distributor shall represent that, any person can or will receive profits or revenues without substantial effort on his own behalf. Under no circumstances, the business opportunity would be portrait as a "Get Rich Quick Scheme".

28.4. No Distributor shall make or advertise any unreasonable or misleading representations in respect of potential earnings.

28.5. A Distributor understands that sponsorship right stands vested to a newly joined Distributor only on completing 1000PPV, engaging in multiple sales transaction.

28.6. All Distributor incentive / commission paid by the company is inclusive of any service tax or other statutory taxes as may be levied by the government and payable in respect of the said Distributor commission and no other additional amount is payable to the Distributors by DXN apart from the bonus or commission as already paid.

28.7. On signing the Direct Seller Application and Agreement form, the applicant / Distributor agrees to receive all communications forwarded by the company to his mailing address, land line, mobile or email including all short messages sent via SMS to his mobile at any time during the day. The said communication shall not be construed as a violation of privacy. Distributor unwilling to receive such messages need to intimate the company in writing.

29. Rights of DXN :

DXN reserves the full and absolute right, at any point of time, even without any prior notice to change, vary or amend or modify the DXN Distributorship Rules and Regulations, Code of Conduct, DXN Marketing plan or any of its policies and to withdraw or suspend or terminate the Distributorship of any Distributor or person as and when necessary.

30. English Version Shall Prevail:

In the event of doubt as to true meaning concerning the DXN Distributorship Rules and Regulations, or any portion thereof in relation to its translated versions, the English Version Shall Prevail.

31 .Arbitration:

Should any dispute arise between DXN and a Distributor, the parties shall attempt to resolve such dispute in good faith by direct negotiations and conciliation. Should the parties fail to resolve the dispute, the dispute shall be submitted to arbitration in accordance with the provisions of the Arbitration and Conciliation Act 1896, but subject to the following:

- (a) The place for arbitration shall be either New Delhi or Chennai;
- (b) There shall be one(1) arbitrator;
- (c) The arbitrator shall be appointed either by mutual consent or by DXN.

DXN MARKETING PLAN
DISTRIBUTOR RULES AND REGULATIONS

